

## Flat roof | south system II

Flat roof system closed II

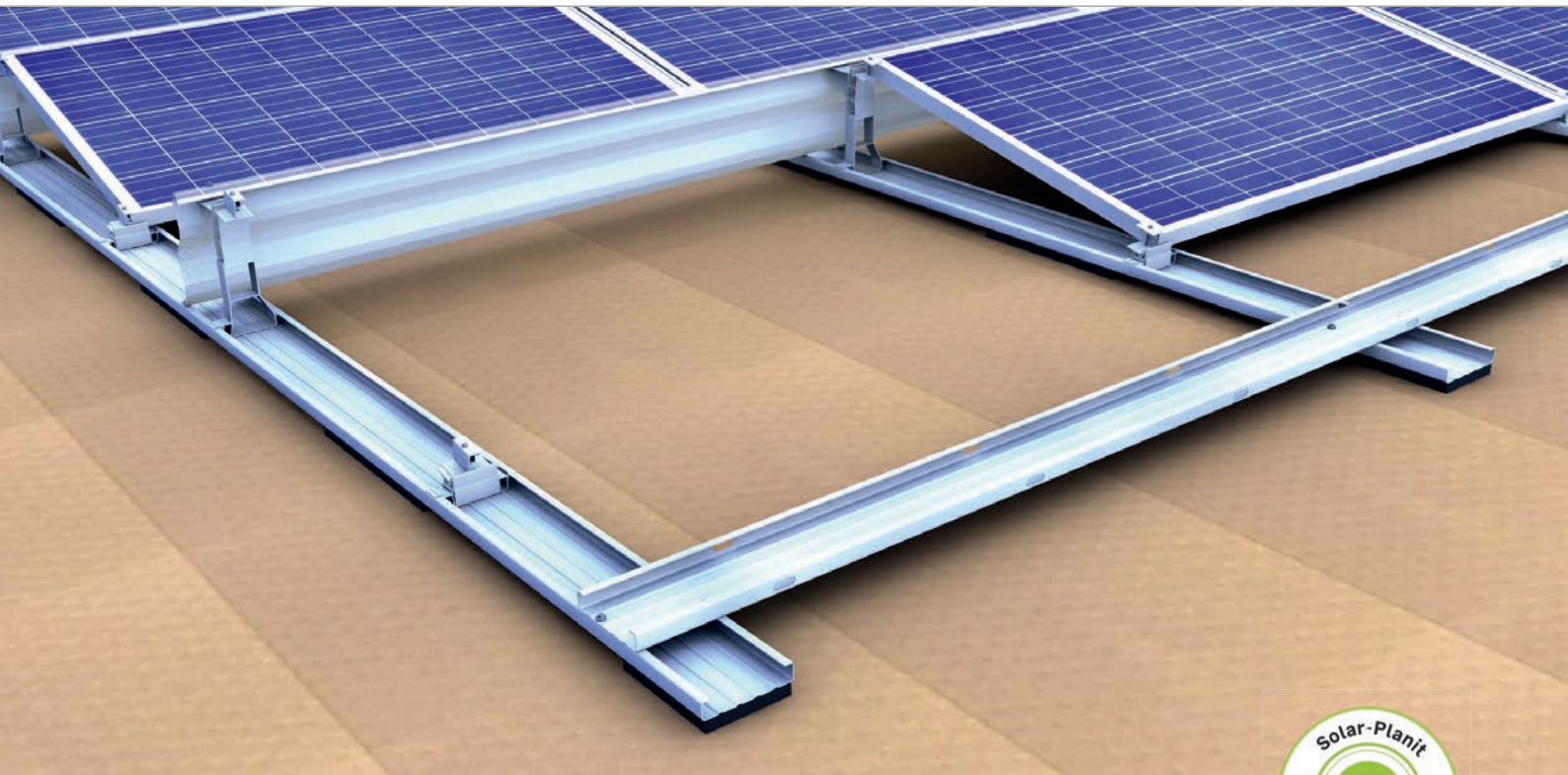
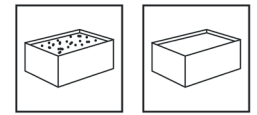

### Our solution for south-facing direction

- optimum module orientation towards south
- optimum elevation angle 13° for good efficiency and self-cleaning
- cross connections at module field edges for high stability
- high flexibility thanks to individually selectable row distance
- connected module fields up 34m length possible

### product variants

- different base troughs: blank, with PE separation layer or with PE pads for cross drainage
- clamps for long frame side, e.g. third base trough for extreme snow and wind loads
- wind deflectors for 72-cell modules (up to 2,18m length)

### Your benefits

- wind-tunnel tested aerodynamics
- wide and continuous base troughs for optimum load redistribution and low surface pressure
- module supports and base feet with click-fit function – no screwing necessary
- suitable for wide modules

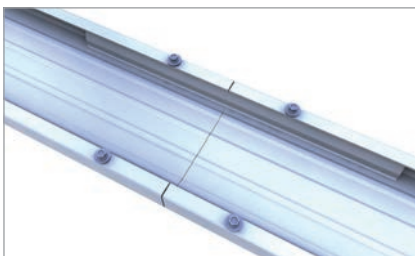

Base trough extension

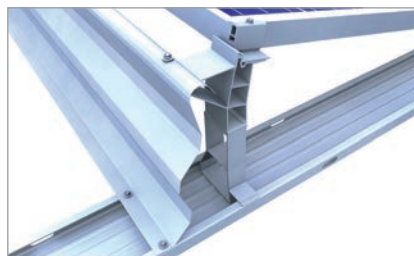

Wind deflector and module support

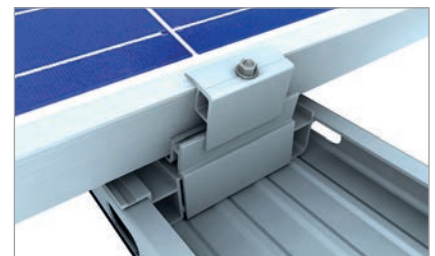

Module clamp long frame side for third base trough

## Flat roof system | south system II

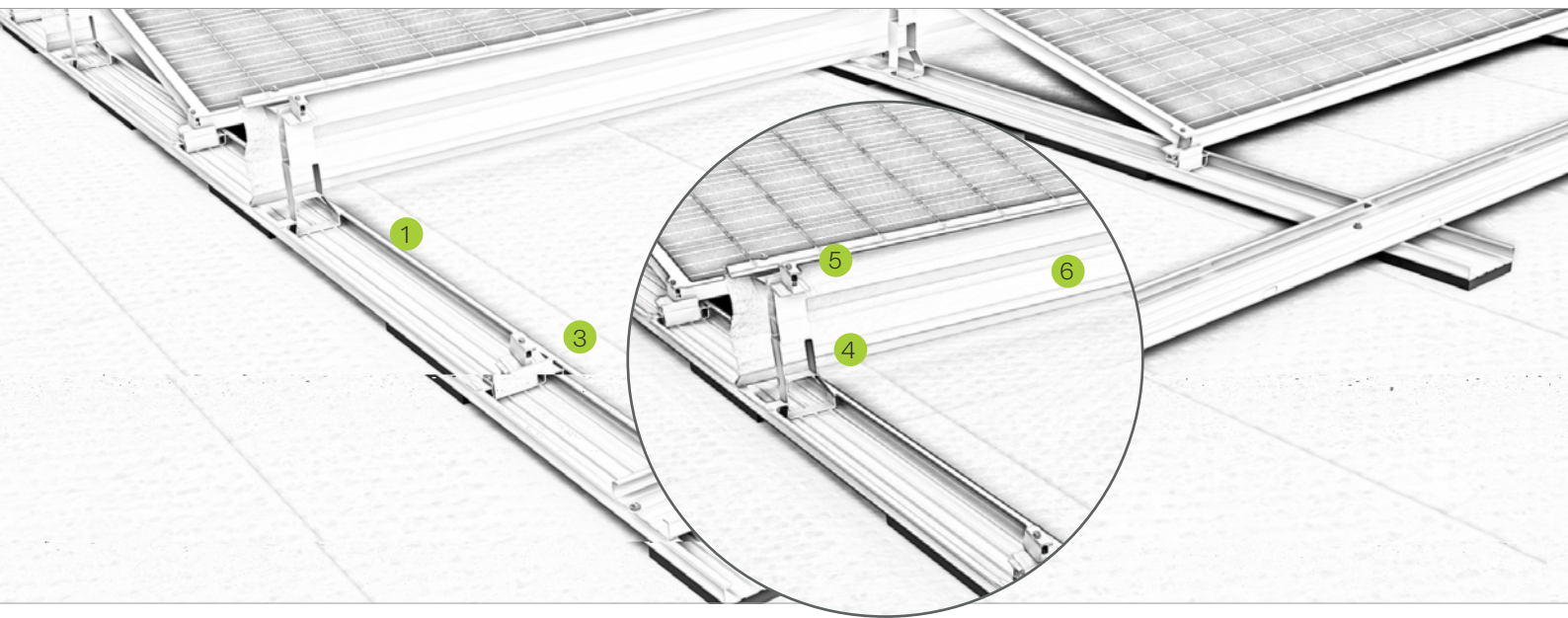

### Pic Designation

- 1** Base trough
  - much space for ballast, optionally Ballast trough available
  - top cover when used as a cable channel
- 2** Connectors and expansion joints
  - connectors for module fields up to 17 m length
  - expansion joints to connect two 17 m module fields
- 3** Base foot
  - quick click-fit without additional screwing
  - predrilled mounting hole for easy positioning
- 4** Module support
  - quick click-fit without additional screwing
  - predrilled mounting hole for easy positioning
- 5** Module bracket
  - entirely pre-assembled
  - screw with drill bit for easy assembly
- 6** Load redistribution via wind deflector
  - for cross connection and load redistribution
  - aerodynamic design und easy installation

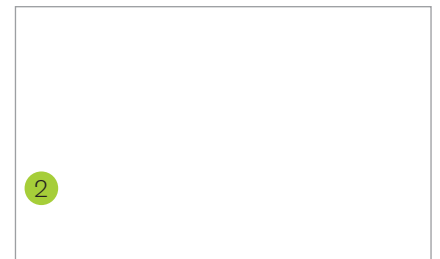

Base foot in base trough with connector

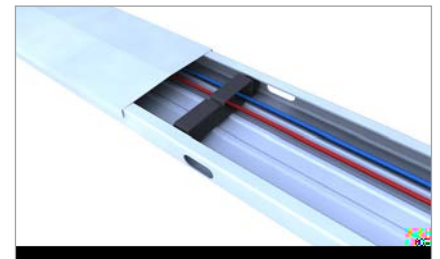

Base trough with cover and cable bracket

Montagevideo



novotegra GmbH  
Eisenbahnstraße 150 | 72072 Tübingen | Deutschland  
Tel. +49 7071 98987-0, info@novotegra.com  
www.novotegra.com

Subject to changes and errors excepted.  
Last updated: April 2021 / TP